

Designed for safety. Built for fun.

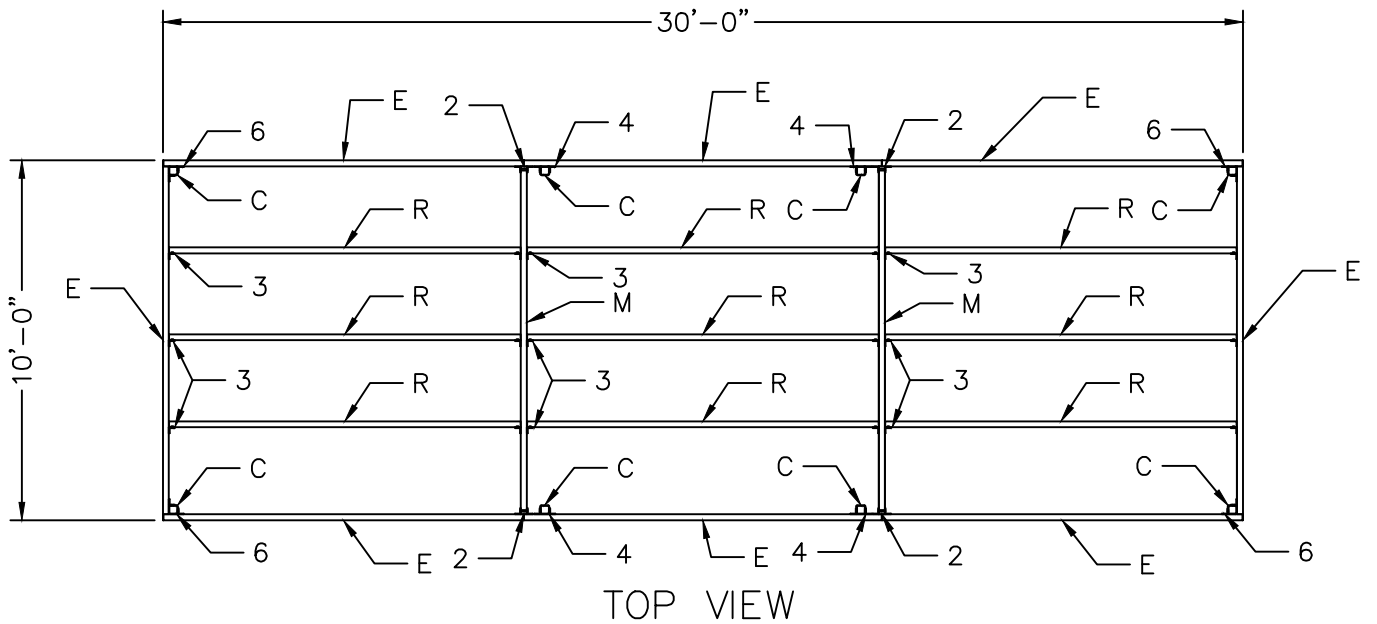

10'x30' Fielders Choice Dugout

Designed for safety. Built for fun.

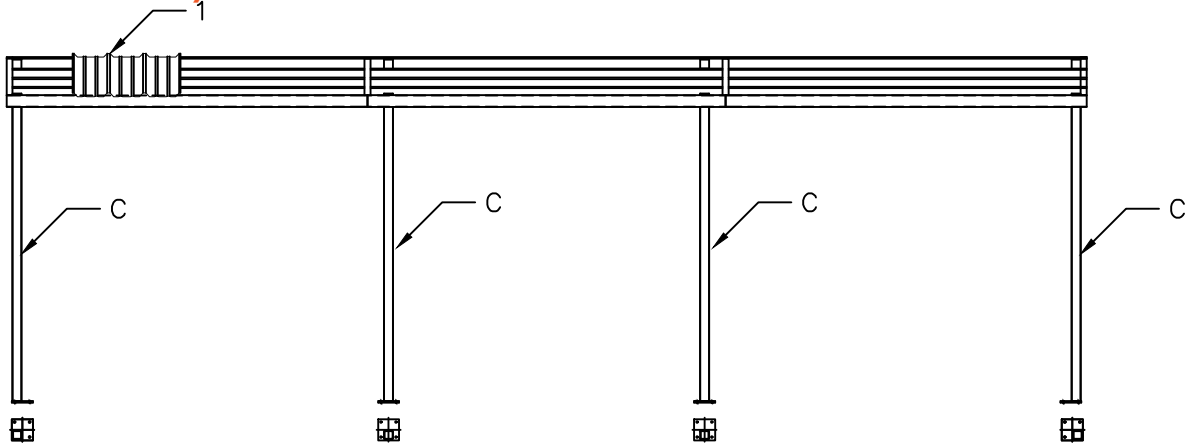

ELEVATION

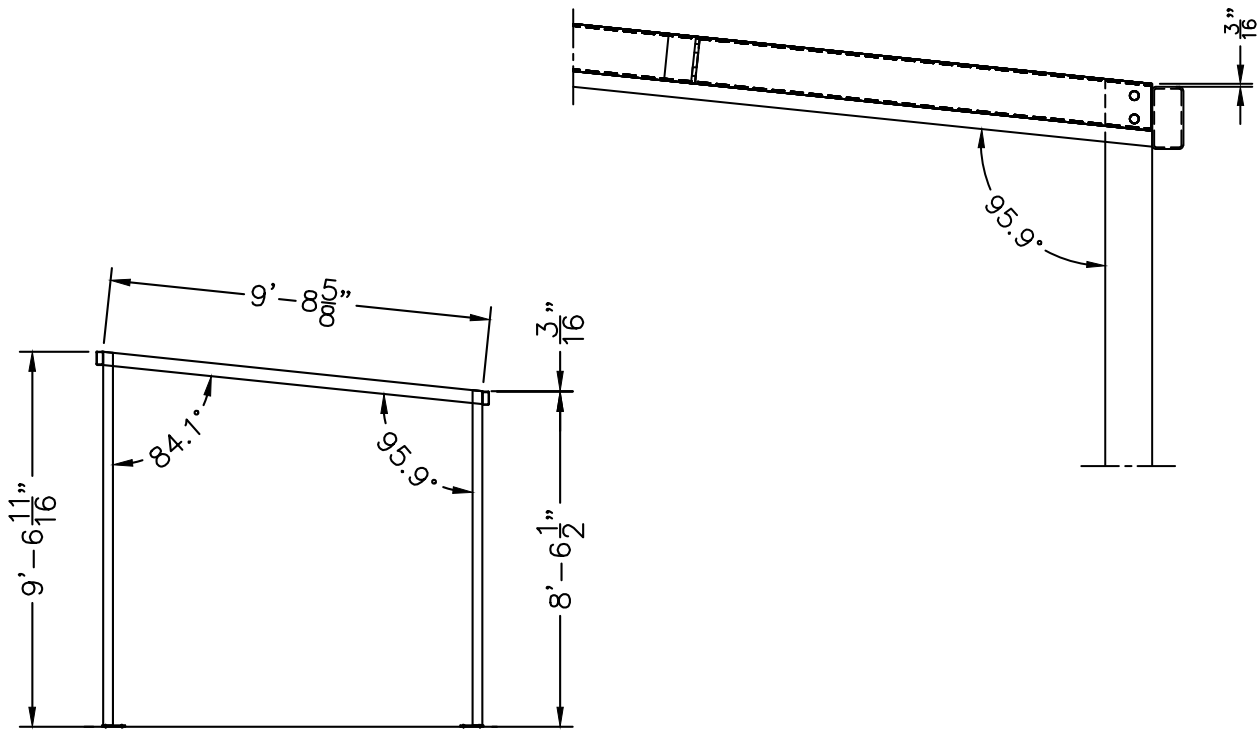

SECTION VIEW

Designed for safety. Built for fun.

GENERAL NOTES:

CODES AND SPECIFICATIONS

1. IBC 2018
2. ASCE 7-16 MIN DESIGN LOADS FOR BUILDINGS AND OTHER STRUCTURES
3. AISC 360-16 CODE OF STD PRACTICE FOR STEEL BUILDINGS

MATERIALS

- STEEL TUBES = ASTM A513 OR A500 MIN
- STEEL PLATE = A36 MIN
- FIELD BOLTS = 1/2" DIA A325 MIN, GALV
- ALL SHOP WELDS TO BE 3/16" FILLET UNLESS NOTED OTHERWISE

ROOF PANELS

- PBR PANEL 1-1/4"x24GAx36" COVER MFR BY METAL SALES OR EQUAL
- LENGTHS AS REQUIRED, 2-SPAN MIN

DESIGN LOADS

1. ROOF LOAD
 - LIVE LOAD 20 PSF MIN (SNOW)
2. WIND LOAD
 - BASIC WIND SPEED (ULTIMATE 3-SEC GUST) 115 MPH (90 MPH 3-SEC GUST ASD)
 - WIND EXPOSURE - C
 - $K_z = 0.85$
 - $K_{zt} = 1.0$
 - $K_d = 0.85$
 - $G = 0.85$

FOUNDATIONS

1. CONCRETE SPECIFIED MINIMUM COMPRESSIVE STRENGTH OF 2,500PSI AT 28 DAYS
2. CONCRETE REINFORCING STEEL SHALL CONFORM TO ASTM A615, GRADE 60
3. ALLOWABLE SOIL BEARING PRESSURE (NET) - 1500 PSF
4. CAST IN PLACE ANCHOR RODS = ASTM F1554 GR55, GALV, UNO
5. FROST LINE DEPTH = 36"

Designed for safety. Built for fun.

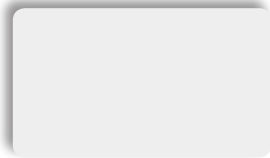

Snowdrift White (W81)



Linen White (81)

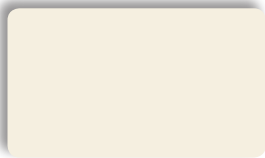

Sandstone (W51)

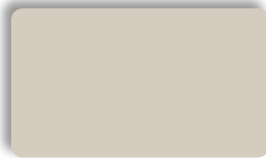

Parchment (W74)

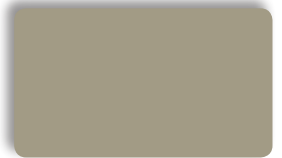

Taupe (74)

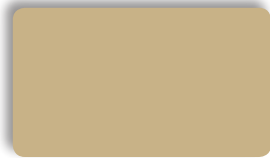

Khaki (88)

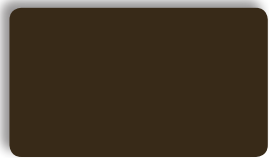

Medium Bronze (H4)

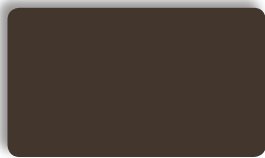

Weathered Copper (W50)

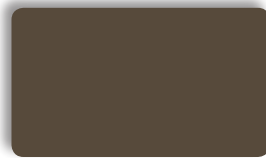

Mansard Brown (133)

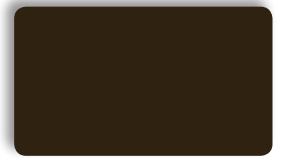

Dark Bronze (50)

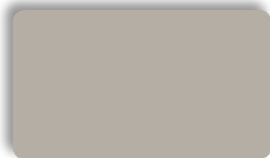

Ash Grey (25)

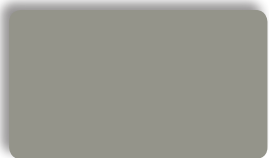

Old Town Grey (W25)

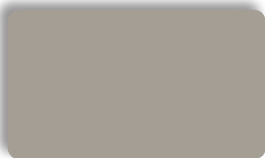

Old Zinc Grey (W29)

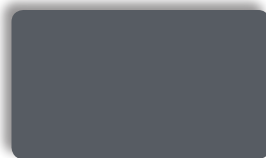

Slate Grey (W38)

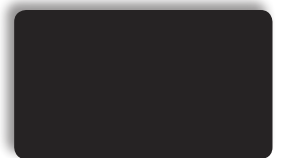

Matte Black (106)

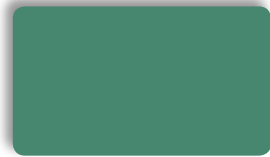

Aged Copper (65)

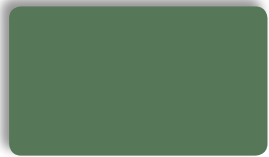

Patina Green (W58)

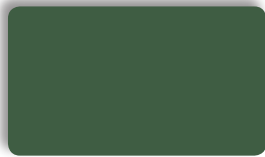

Hemlock Green (M7)

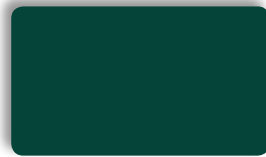

Classic Green (66)

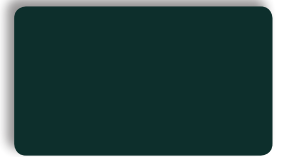

Felt Green (W66)



Patriot Red (73)

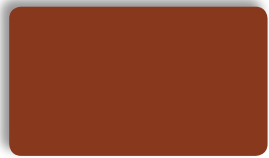

Terra Cotta (W72)

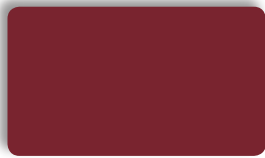

Colonial Red (W75)

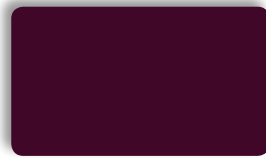

Brandywine (P8)

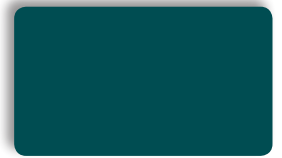

River Teal (59)



Metallic Silver (K7)¹

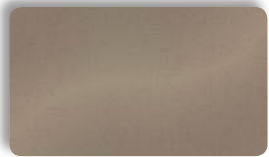

Champagne Metallic (168)¹

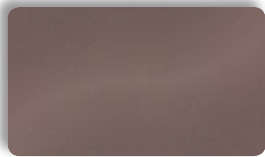

Mistique Plus (W31)¹



Copper Penny (W92)¹

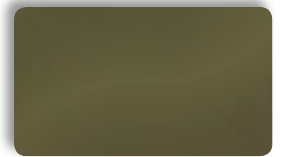

Antique Patina (M1)¹



Tahoe Blue (W71)

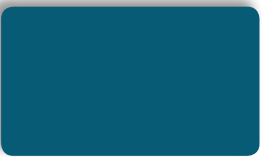

Ocean Blue (35)

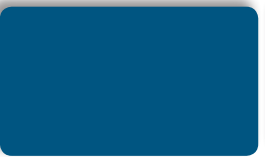

Regal Blue (W35)

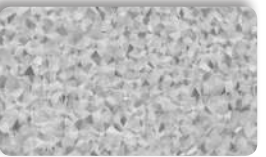

Galvalume® (41)
 Non-painted Finish
 25 Year Warranty

Dugout Roof Color Options