

Designed for safety. Built for fun.

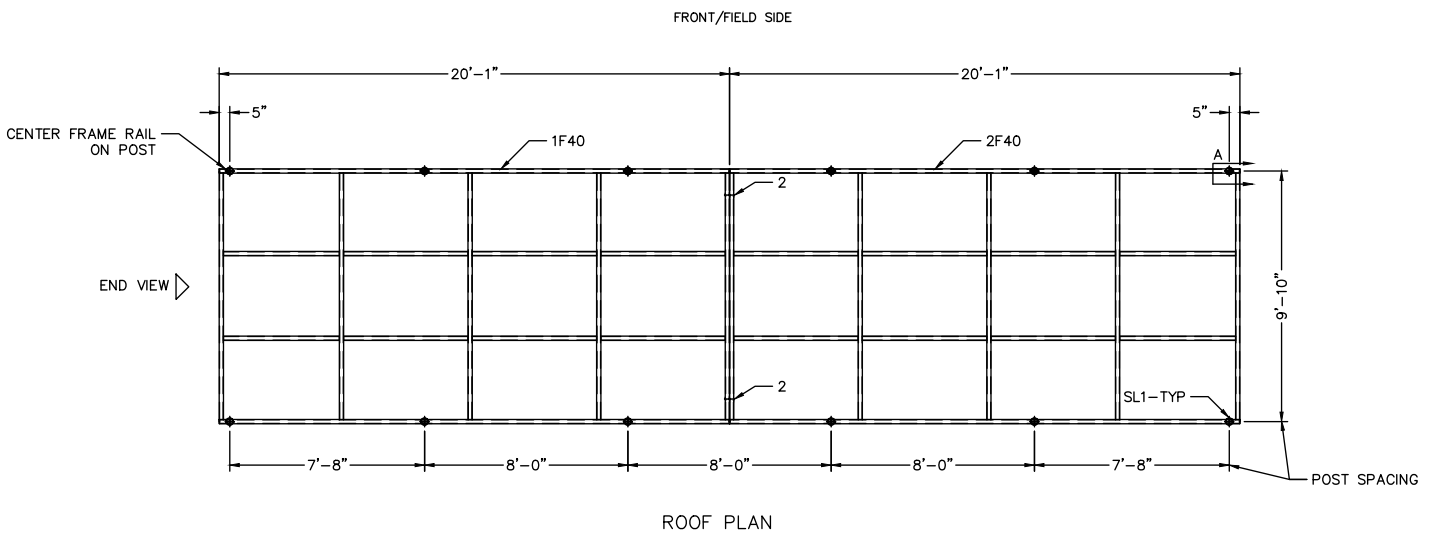

10'x40' Fielders Choice Dugout Cover

Designed for safety. Built for fun.

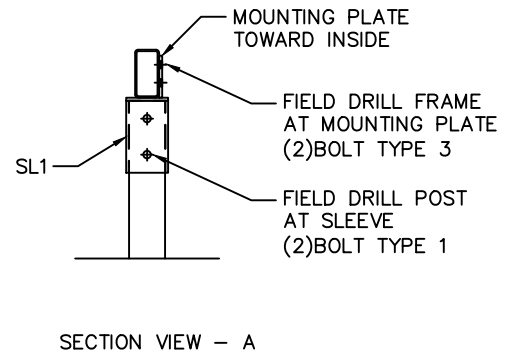
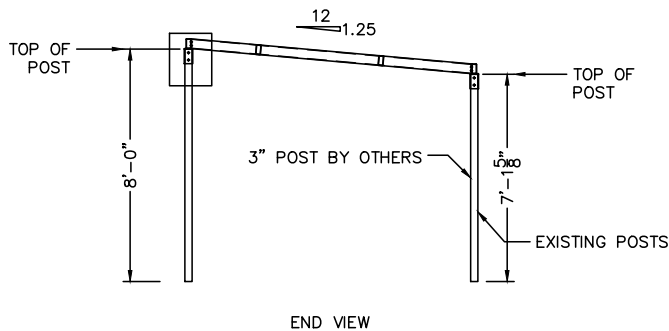

GENERAL NOTES:

CODES AND SPECIFICATIONS

1. IBC 2018
2. ASCE 7-16 MIN DESIGN LOADS FOR BUILDINGS AND OTHER STRUCTURES
3. AISC 360-16 CODE OF STD PRACTICE FOR STEEL BUILDINGS

MATERIALS

- STEEL TUBES = ASTM A513 OR A500 MIN
- STEEL PLATE = A36 MIN
- FIELD BOLTS = 1/2" DIA GR5 MIN, GALV OR ZINC
- ALL SHOP WELDS TO BE 3/16" FILLET UNLESS NOTED OTHERWISE

ROOF PANELS

- PBR PANEL 1-1/4"x24GAx36" COVER MFR BY METAL SALES OR EQUAL
- LENGTHS AS REQUIRED, 2-SPAN MIN

FINISHES

- PRIME TNE MEC SERIES 161
- PAINT TNE MEC SERIES 1074, COLOR TBD

DESIGN LOADS

1. ROOF LOAD
 - LIVE LOAD 20 PSF MIN (SNOW)
2. WIND LOAD
 - BASIC WIND SPEED (ULTIMATE 3-SEC GUST) 115 MPH (90 MPH 3-SEC GUST ASD)
 - WIND EXPOSURE - C
 - $K_z = 0.85$
 - $K_{zt} = 1.0$
 - $K_d = 0.85$
 - $G = 0.85$

FOUNDATIONS

1. CONCRETE SPECIFIED MINIMUM COMPRESSIVE STRENGTH OF 2,500PSI AT 28 DAYS
2. CONCRETE REINFORCING STEEL SHALL CONFORM TO ASTM A615, GRADE 60
3. ALLOWABLE SOIL BEARING PRESSURE (NET) - 1500 PSF
4. CAST IN PLACE ANCHOR RODS = ASTM F1554 GR55, GALV, UNO
5. POST INSTALLED ANCHORS = 1/2 x 4 EMBED MIN LDT OR EPOXY ANCHOR
5. FROST LINE DEPTH = 36"

Post Saddle

