

Designed for safety. Built for fun.

# 8-211

\* Images not to scale

3/4" MDO (Medium Density Overlay) Signboard Material

1/4" Exterior Treated Plywood Back Panel

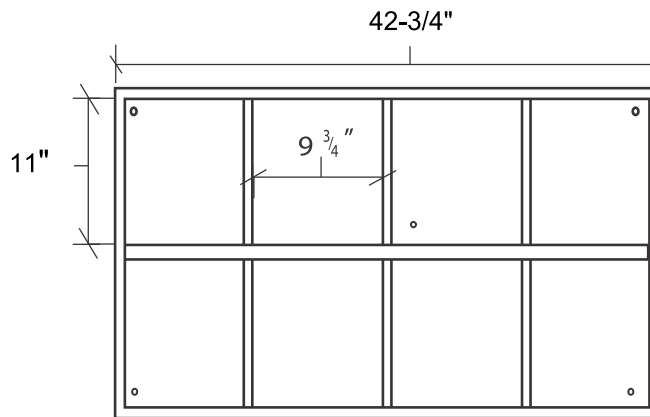
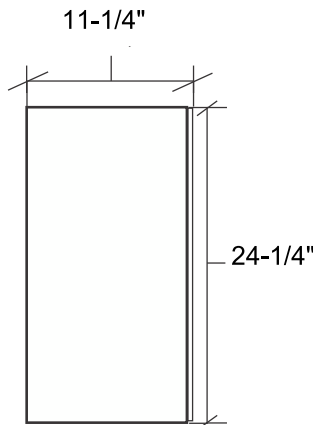
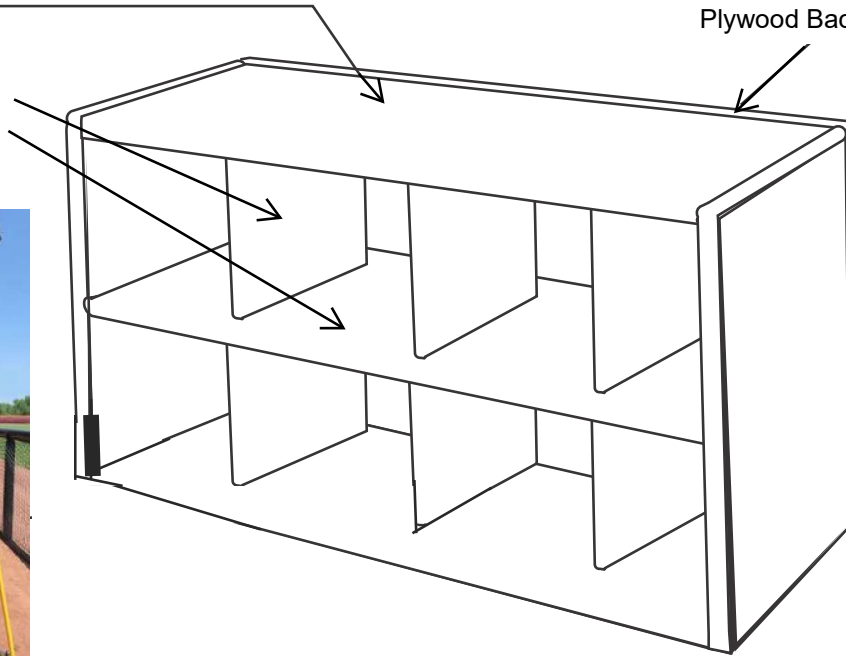

**Proprietary Notice**  
Information within this document is the property of PYT Sports Inc. Any reproduction, in part or as a whole, without the written permission of PYT Sports Inc. is strictly prohibited

\*Includes hardware for concrete block attachment. Fence attachment option (upgraded 1/2" MDO back and fence attachment hardware) is also available upon request at a minimal fee.

Painted With Two Coats Of Exterior Enamel Paint  
Mounting Styles Available For: Concrete Block, Wood Or Fence Dugouts  
No Assembly Required  
Each Order Includes One Can of "Touch Up" Paint For Post Installation

## 8-211 Helmet Rack